



STRUCTURE  HOME INSULATION SYSTEM™



Mastic products are part of the **Cornerstone Building Brands** family of products, America's leader in creating beautiful residential and commercial exteriors.

Our Mastic siding products carry a superior warranty, providing comfort as you create the exact home you want for decades to come. And thanks to the industry's most advanced engineering processes, Mastic products deliver darker colors and better performance than were possible just a few years ago.

Dream big on your new home or remodeling project—with Mastic.





STRUCTURE® HOME INSULATION SYSTEM™

The solid look of wood. The low maintenance of vinyl. The comfort of a thick layer of insulation. It's a combination that enhances curb appeal, lowers energy bills and adds value. It's a system that improves your quality of life.

INSULATED



COMFORT is a thick layer of insulation surrounding your home. It's being warm in winter and cool in summer. It's keeping unwanted noise out. It's saving energy year-round.





A continuous blanket of insulation

Most homes have insulation between the studs in exterior walls. But heat can escape in winter (and enter your home in summer) through gaps and holes around windows, doors and across wall studs.

Structure Home Insulation System not only covers exterior walls with a layer of continuous insulation, it also covers problem areas around windows, doors and corners with a range of insulated accessories.

STUDS IN YOUR WALL TRANSFER HEAT. COVERING THEM WITH INSULATION SAVES ENERGY.

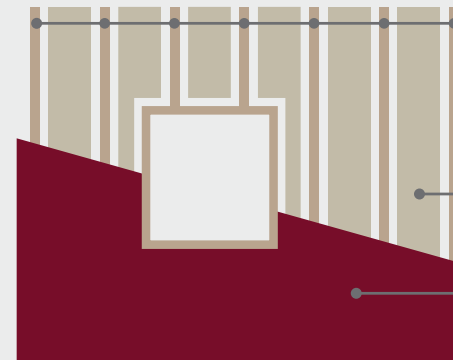

Studs create a thermal bridge for heat to escape in winter and enter your home in summer. Because studs can represent up to 25 percent of the wall surface, it's like having an entire wall without significant insulation.

Insulation between the wood studs in an exterior wall.

Structure Home Insulation System covers the entire wall with a thick layer of insulation to prevent thermal bridging.

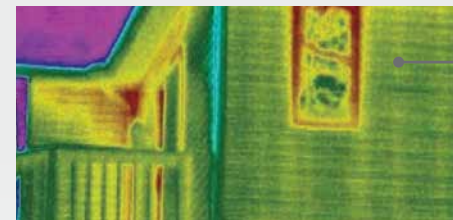

Thermal bridging through the studs and wall intersections is revealed with an infrared camera.¹

STRUCTURE HOME INSULATION SYSTEM HAS GREATER INSULATING POWER THAN OTHER CLADDING OPTIONS.

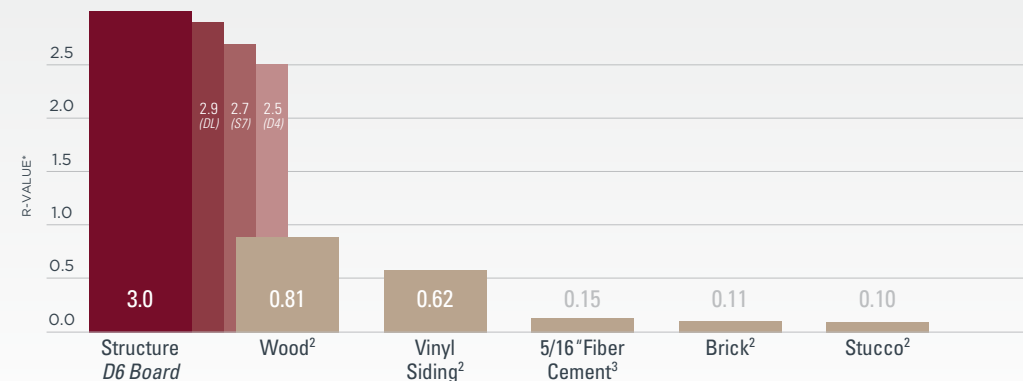

*R-value means resistance to heat flow. The higher the R-value the greater the insulating power.

¹Side-by-Side, All Siding Isn't Created Equal, Page 3, by Insulated Siding with Fullback Technology™, Progressive Foam.

²<http://www.progressivefoam.com/replacing-vinyl-siding>

³http://www.icc-es.org/reports/pdf_files/NES/NER405.pdf



Protects inside and out

The average family of four produces four to six gallons of water vapor each day. That water vapor must be allowed to escape to prevent moisture from accumulating and causing problems in your walls.

Like today's high-performance clothing, Structure Home Insulation System allows moisture generated by your daily activities to escape while protecting you from the elements.

Insulated

TRIPLE PROTECTION AGAINST THE ELEMENTS

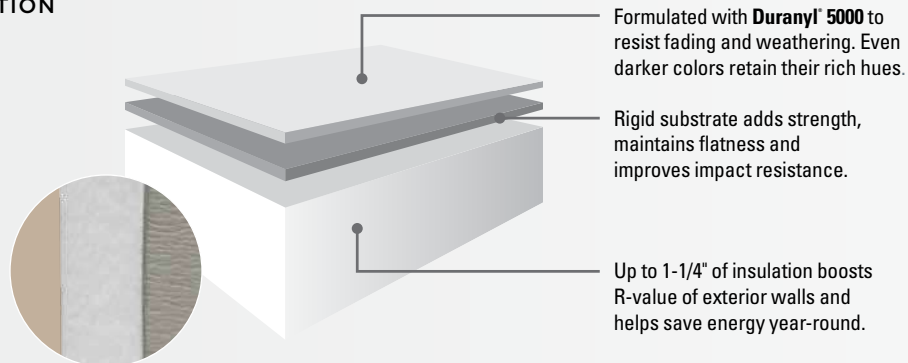

BREATHABLE INSULATION FOR A HEALTHIER HOME

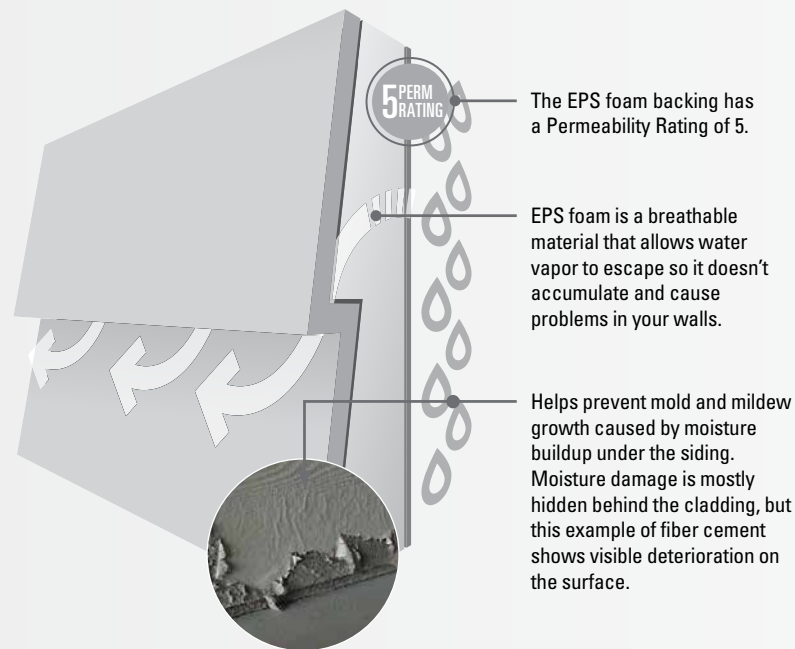



BEAUTIFUL



BEAUTY is in the look and feel of solid wood. It's an authentic cedar grain with a low-maintenance finish. It's wide panels with dramatic shadow lines. It's the best-looking house on the block.





Solid curb appeal

When you combine rigid foam insulation and vinyl siding, you get a solid panel that looks and feels like traditional wood siding. The panels are broader than ordinary vinyl siding and they maintain their shape under pressure. The foam backing also tightens the seams between the panels for attractive, straight lines and added curb appeal.

Beautiful

**WIDE RANGE OF COLORS
FROM LIGHTER SHADES
AND EARTH TONES TO
DARKER HUES**

**LAYS FLAT OVER
IMPERFECTIONS IN
WALL SURFACES FOR
A STRAIGHT, UNIFORM
APPEARANCE**

**COORDINATES WITH A
VARIETY OF COLORS,
TEXTURES AND
MATERIALS**

**SOME PROFILES AVAILABLE
IN LONGER 16' 8" LENGTHS
FOR A NEARLY SEAMLESS
INSTALLATION**





Beautiful

Choose from
a broad color
palette.

To see how different
colors might look on
your home, try our
visualizer options at
mastic.com/getstarted.

Color key

- S7** SINGLE 7"
- S7^L** SINGLE 7"
LONG LENGTH
- D6** DOUBLE 6"
- D6^L** DOUBLE 6"
LONG LENGTH
- DL** DOUBLE 4-1/2"
DUTCH LAP
- D4** DOUBLE 4"
- ALL** ALL PANELS
AND LENGTHS

Due to printing limitations, colors
may not be exactly as shown. Refer
to actual sample and color chips for
best match.

DEEP COLORS >

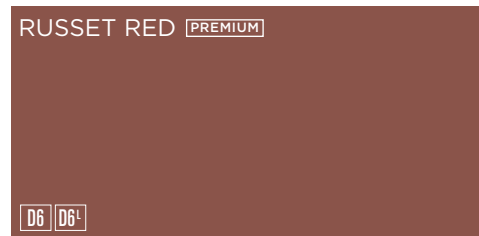
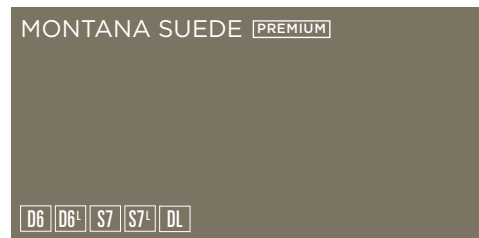
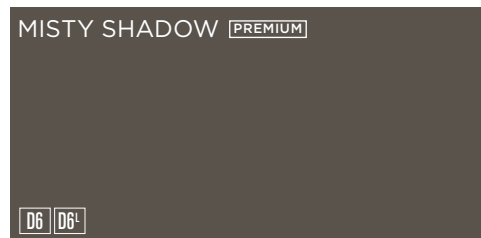
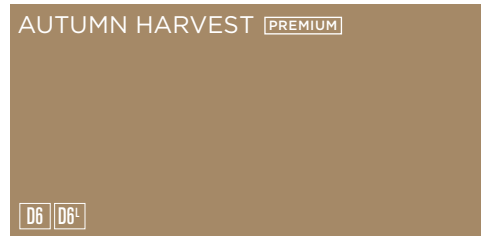

CLASSIC COLORS >

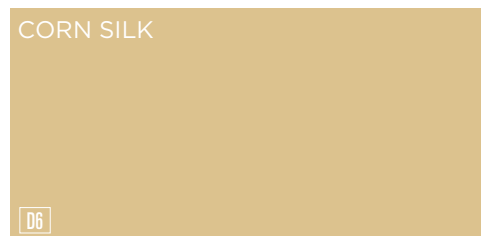

PEBBLESTONE CLAY

ALL

SCOTTISH THISTLE

ALL

Explore the possibilities.
With our new interactive design tool, you can apply different combinations of colors and products to see how they look. Bring your vision to life at mastic.com/visualizer.



LIGHT COLORS >

ALMOND

D4 DL D6 S7

CAMEO

D4 DL D6 S7

CLASSIC CREAM

D4 DL D6 S7 S7*

DESERT SAND

ALL

LINEN

D4 DL D6 S7

SAGE

D4 DL D6 S7

SANDTONE

D4 DL D6 D6* S7

SILVER GREY

D4 DL D6 S7

VICTORIAN GREY

ALL

WICKER

ALL

WHITE

ALL

STRONG



STRENGTH is hanging tough in high winds. It's not warping in extreme heat or cracking in freezing temperatures. It's absorbing hits from hail and foul balls. It's lasting beauty.





Up to 300 percent more impact resistance

The EPS foam bonded to our panel acts as a shock absorber to provide up to 300 percent more impact resistance than standard vinyl siding. In testing, Structure Home Insulation System withstood hammer blows that damaged lesser siding products.

Strong

STRUCTURE HOME INSULATION SYSTEM PROVIDES GREATER STRUCTURAL INTEGRITY.

The foam backing, double nail hem and secure locking system create stronger, more rigid panels with tighter seams.

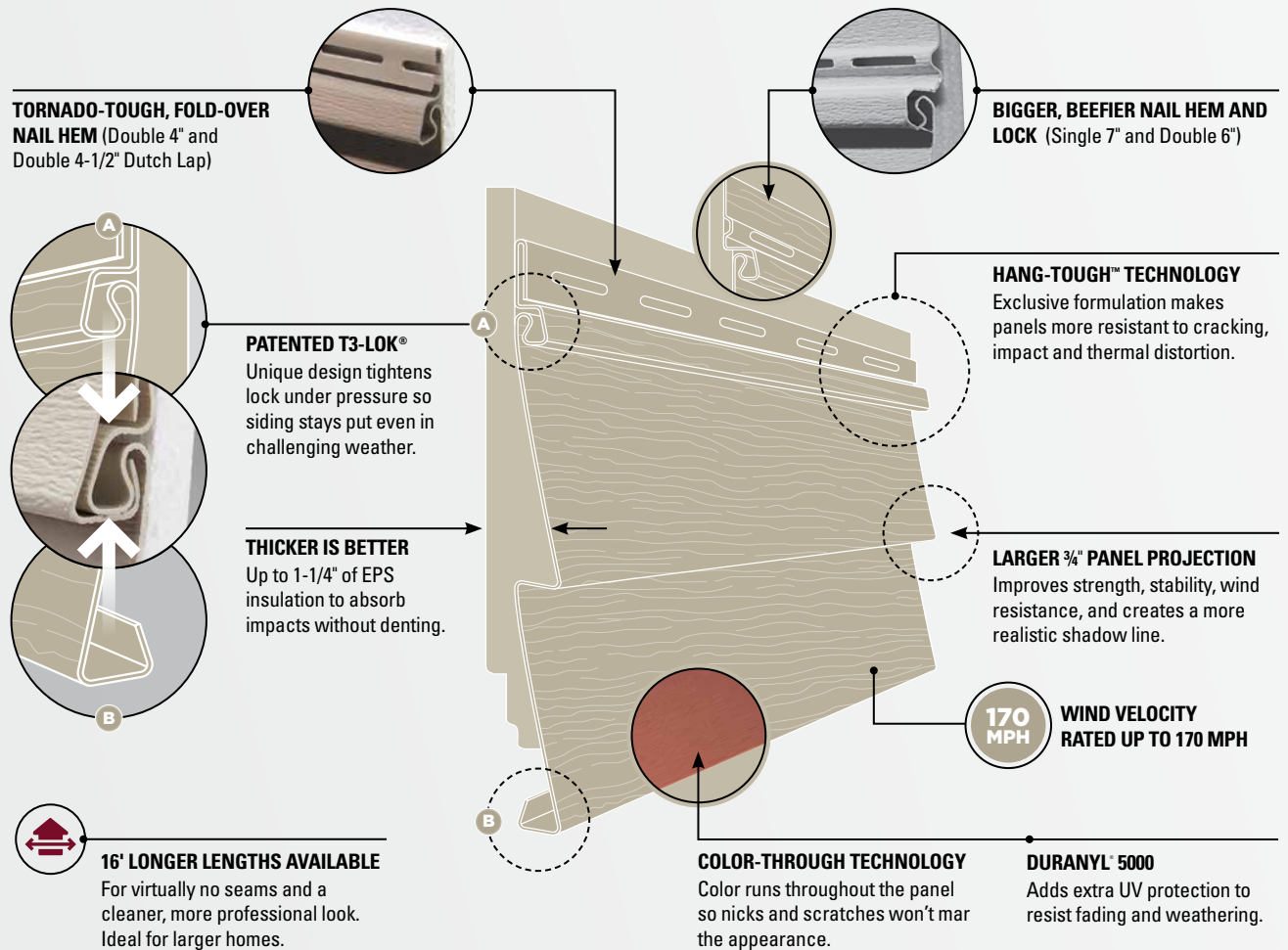

SUSTAINABLE



SUSTAINABILITY is using less energy to heat and cool your home. It's using recycled materials to conserve resources. It's protecting your home without polluting the environment.



This beautiful smart home received Florida's first Gold-Level Leadership in Energy and Environmental Design (LEED) home certification using Structure Home Insulation System.

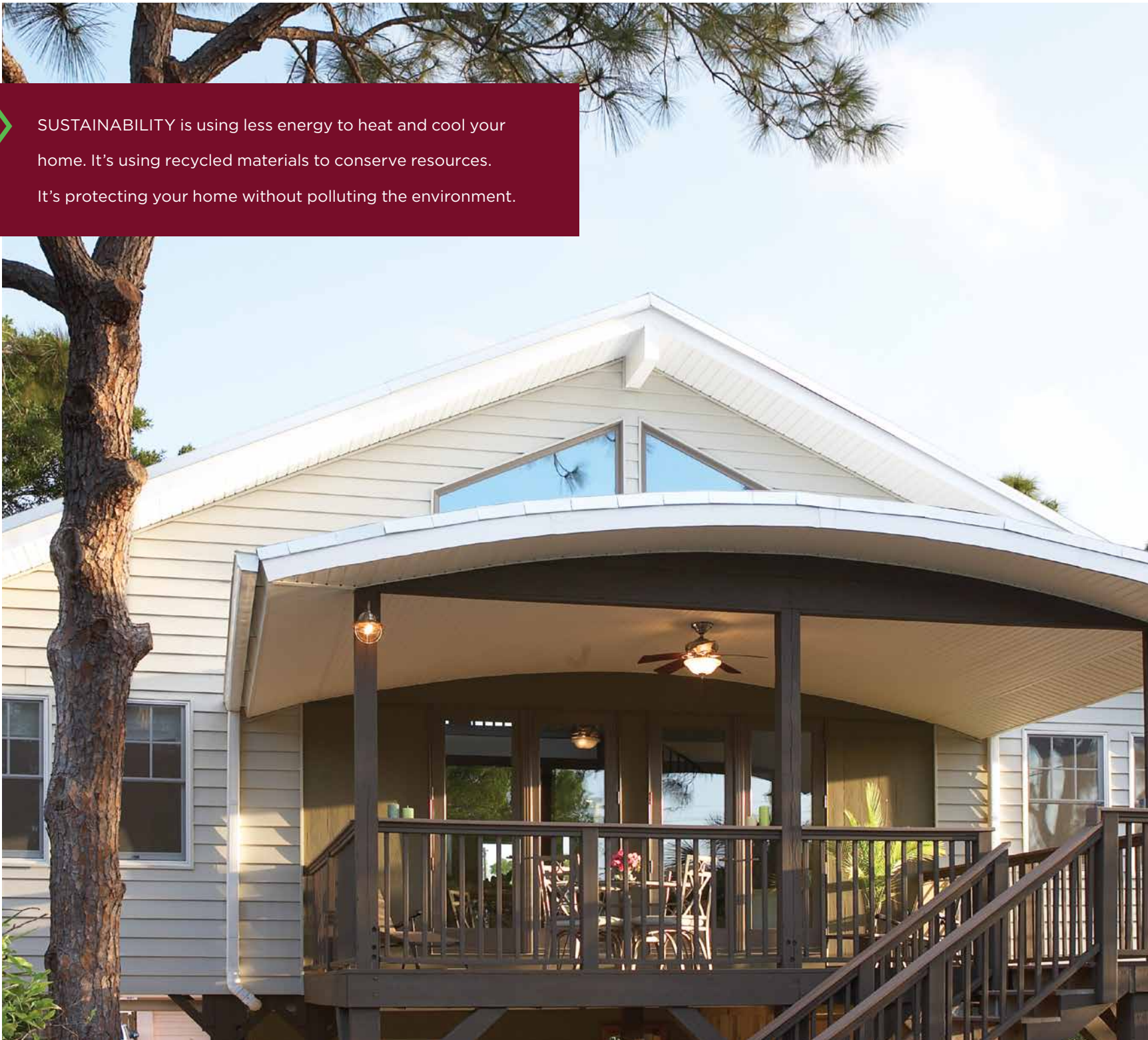



A greener choice for your home

Structure Home Insulation System can help you meet your sustainable building goals. It's engineered to last a lifetime. It never needs painting or staining (unlike fiber cement, which requires repainting over time). And its thick layer of insulation boosts the R-value of your exterior walls, reducing energy consumption and helping to shrink your carbon footprint.

Sustainable

MADE FROM ABUNDANT NATURAL RESOURCES

The vinyl in our panels is derived from two natural resources: salt (57 percent) and natural gas (43 percent). Additives such as stabilizers and antioxidants increase durability and enhance performance.



ENVIRO SNAP SHOT:

LEED For Homes — Possible Points

1 – 37

LEED New Construction — Possible Points

3 – 12

NAHB Standards — Possible Points

61 – 192

WORRY-FREE



PEACE OF MIND is lasting beauty. It's the end of costly painting and repairs. It's a trusted brand that stands behind its products. It's knowing you made the right choice.





There's no better choice for your home

When you combine lasting beauty with a lifetime of low maintenance and greater comfort, it's hard to beat. Add up the savings on painting, repairs and monthly energy bills and Structure Home Insulation System looks even better. To learn more, ask your Mastic contractor for color samples and product specifications.

Worry-Free

LIFETIME WARRANTY

Structure Home Insulation System is backed by our V.I.P. Limited Lifetime Warranty, which covers against manufacturing defects, excessive fading and hail damage for as long as you own your home. To protect your investment, the warranty is transferable in the event you sell your home (see warranty for details).



THIRD-PARTY TESTED FOR QUALITY

In addition to our own quality controls, Structure Home Insulation System is tested and inspected by a third party for color retention, consistency, weatherability, impact strength and windload resistance (ASTM D6864, D3679).



Consult the VSI website at www.vinylsiding.org for a current list of certified products and colors.

NEVER NEEDS PAINTING OR STAINING

Unlike wood, stucco or fiber cement, Structure Home Insulation System never needs painting or staining, which saves you time and money year after year.



COMPARE MAINTENANCE COSTS

Structure: \$5 (just soap and water)

Other cladding options: up to \$5,000
(Based on typical prep, caulking and repainting of the average home)

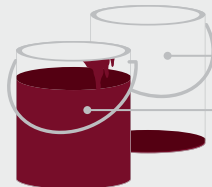

DL



DOUBLE 4.5"
DUTCH LAP
R-VALUE: 2.9

DL

Unlike standard lap siding, which has flat panels that overlap each other at an angle, Dutch Lap has a decorative groove between the laps. This groove improves strength, adds depth and creates wider shadow lines. It's a popular choice for Colonial and Victorian style homes, as well as hipped-roof styles such as Prairie. Each Double 4.5" DL panel includes two four-and-a-half-inch-wide laps per panel.



Structure Home Insulation System Double 4.5" Dutch Lap in Linen

RUGGED CANYON [PREMIUM]

ENGLISH WEDGEWOOD [PREMIUM]

QUIET WILLOW [PREMIUM]

MONTANA SUEDE [PREMIUM]

HARBOR GREY

EVEREST

SCOTTISH THISTLE

PEBBLESTONE CLAY

VICTORIAN GREY

WICKER

SANDTONE

SAGE

DESERT SAND

SILVER GREY

ALMOND

CLASSIC CREAM

LINEN

CAMEO

WHITE

D6



DOUBLE 6"
TRADITIONAL LAP
R-VALUE: 3.0



D6

The Double 6" style offers wider laps than the D4 and brings a classic look to almost any home. Each D6 panel includes two six-inch-wide laps on each panel.

Double 6" Traditional Lap is also available in longer 16' panels for nearly seamless installation. This  icon indicates colors available in the long length panel.



Structure Home Insulation System Double 6" in Everest

- RUSSET RED PREMIUM 
- RUGGED CANYON PREMIUM 
- DEEP GRANITE PREMIUM 
- ENGLISH WEDGEWOOD PREMIUM 
- QUIET WILLOW PREMIUM 
- MONTANA SUEDE PREMIUM 
- MISTY SHADOW PREMIUM 
- VINEYARD GROVE PREMIUM 
- AUTUMN HARVEST PREMIUM 
- CORN SILK
- HARBOR GREY 
- EVEREST 
- SCOTTISH THISTLE 
- PEBBLESTONE CLAY 
- VICTORIAN GREY 
- WICKER 
- SANDTONE 
- SAGE
- DESERT SAND 
- SILVER GREY
- ALMOND
- CLASSIC CREAM
- LINEN
- CAMEO
- WHITE 

D4

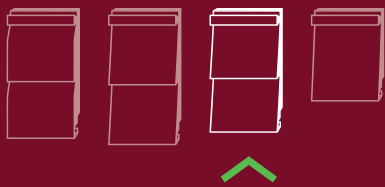

DOUBLE 4"
TRADITIONAL LAP
R-VALUE: 2.5

D4

The Double 4" style is modeled on traditional wood lap siding with panels that overlap one another. Each D4 panel includes two four-inch-wide laps on each panel. The narrower laps of the D4 panel can make a smaller home appear larger.



Structure Home Insulation System™ Double 4" in Victorian Grey

HARBOR GREY

EVEREST

SCOTTISH THISTLE

PEBBLESTONE CLAY

VICTORIAN GREY

WICKER

SANDTONE

SAGE

DESERT SAND

SILVER GREY

ALMOND

CLASSIC CREAM

LINEN

CAMEO

WHITE

S7



SINGLE 7"
TRADITIONAL LAP
R-VALUE: 2.7



S7

The Single 7" style is right at home on a traditional or contemporary house. It offers a classic lap board look with wide 7-inch panels. The foam backing supports the panel and gives it the solid look and feel of wood lap siding.

Single 7" Traditional Lap is also available in longer 16' panels for nearly seamless installation. This  icon indicates colors available in the long length panel.



Structure Home Insulation System Single 7" in Sage

- RUGGED CANYON PREMIUM 
- ENGLISH WEDGEWOOD PREMIUM
- QUIET WILLOW PREMIUM 
- MONTANA SUEDE PREMIUM 
- HARBOR GREY 
- EVEREST 
- SCOTTISH THISTLE 
- PEBBLESTONE CLAY 
- VICTORIAN GREY 
- WICKER 
- SANDTONE
- SAGE
- DESERT SAND 
- SILVER GREY
- ALMOND
- CLASSIC CREAM 
- LINEN
- CAMEO
- WHITE 







Finish your home with style and charm

Choose the distinctive detailing of lineals and corner posts to add a touch of elegance to your home's exterior. For more flair, consider adding the traditional beauty of crown molding to your soffit. Each accessory is specifically designed for use with the Structure Home Insulation System for a cleaner look and a uniquely detailed touch.

Accessories

OUTSIDE CORNERS

Wider 5" corners add drama and substance. Color options add character and distinctive style.



WINDOW FINISH

Our wider lineals add authentic architectural detail around windows and doors, and at corners.



INSIDE CORNERS

Bring your walls together with an architecturally correct concave inside corner.





A HEALTHY RESPECT FOR THE PLANET – AND OUR CUSTOMERS.

Our products offer features that positively contribute to sustainable practices, improved energy efficiency or lifecycle benefits of homes. All are foundational elements of sustainable building reflected in our Enviro initiative.



SUSTAINABLE RESOURCES:

- Mastic® vinyl siding is manufactured from two abundant natural resources: salt (57 percent) and natural gas (43 percent).¹
- During the manufacturing process of our vinyl siding, all unused material is reclaimed and reused, creating one of the most efficiently-produced exterior claddings available today.
- When installed and used properly, Mastic® products never require paint or stain, which reduces VOCs released into the atmosphere.
- Mastic Performance Metals® have been third-party verified and Green Circle certified to contain a minimum of 67 percent recycled content.
- Our facilities reuse and recycle pallets and packaging material, reducing raw material needs and landfill use.



ENERGY EFFICIENCY:

- Vinyl siding requires less energy to manufacture per square foot than brick and mortar.²
- Mastic® vinyl siding is lighter weight per square than other cladding options, so it requires less fuel to transport. Less fuel used means less pollution.
- When correctly installed, the Structure Home Insulation System™ can reduce thermal bridging and help meet the requirements of an ENERGY STAR® Qualified new home. The Structure Home Insulation System™ in a Double 6" profile has an R-value³ of R-3.0 using the testing method ASTM C1363, as specified by the Federal Trade Commission.
- Mastic Performance Metals® V-Groove soffit and roof and eave vents support proper attic ventilation efforts, which moderates attic temperatures and improves a home's energy efficiency. Mastic® V-Groove metal soffit provides the most net free ventilation per linear foot of any aluminum soffit system.



LIFECYCLE BENEFITS OF HOMES:

- Mastic® vinyl siding is durable and requires no site finish. Our Performance Metals® stand up to weather with virtually no maintenance. Our Designer Accents™ use thicker construction and a baked lacquer finish to ensure that they hold up season after season.
- When installed properly and under normal use, our products should never require painting or staining. They won't crack, peel, blister or rot.
- All of our Performance Metals® aluminum accessories are easily recyclable. In fact, at the end of its lifecycle in building applications, 100 percent of the aluminum can be recycled.



INSULATED VINYL SIDING ENVIRO SNAP SHOT:

LEED For Homes — Possible Points

1 - 37 61

LEED New Construction — Possible Points

3 - 12 26

NAHB Standards — Possible Points

61-192

1 - "A Dozen Things You Might Not Know That Make Vinyl Siding Green," page 9, Tad Radzinski, P.E., LEED AP, and VSI. October 10, 2009. www.vinylsiding.org/greenpaper

2 - Ibid, page 10

3 - R means resistance to heat flow. The higher the r-value, the greater the insulating power.



Home Innovation
NGBS GREEN CERTIFIED™

Looking for Mastic products with features that can contribute to overall energy savings, lower maintenance and reduced environmental impact? These logos identify products recognized by third parties as supporting green building practices.



Mastic supports green building and it shows. We are active members of both the USGBC and NAHB — two key organizations that are working to define sustainable building practices.



GIVE YOUR HOME THE PERFECT FINISH

The big things like siding and windows make the house, but it's the finishing touches that make it home. So start with the rich texture of shakes or the crisp shadow lines of lap siding, but finish with charming shutters, expertly crafted trim or rustic stone. Creating your dream home exterior can start and finish with our Mastic and Ply Gem products. Every product we make is designed to perform and look beautiful together. Because a house is a home when it's **perfectly finished**.

SIDING + ACCESSORIES | WINDOWS + DOORS | STONE VENEER | TRIM + MOULDINGS



Home Design Made Easy.

It's simple to begin designing your dream home with the new Ply Gem® Home Design Visualizer.

Visit mastic.com/visualizer



GET STARTED

CHOOSE A HOUSE OR UPLOAD YOUR OWN

It's that easy, just select from a variety of home styles or upload a picture of your own home to see the transformation.

ADD COLOR + VISUALIZE

THE INTERACTIVE DESIGN TOOL

Try the new Ply Gem® Home Design Visualizer, a quick and easy way to see what different products, colors and palettes look like on your home.



| FENCE + RAILING



mastic.com
800 962 6973

CORNERSTONE BUILDING BRANDS
5020 WESTON PARKWAY
CARY, NC 27513

We reserve the right to alter, modify or delete items from time to time without notice. Due to printing limitations, colors may not be exactly as shown. Contact your distributor or sales representative for actual product and color samples. ALL PRODUCTS MADE IN THE U.S.A.

© 2020 Mastic Home Exteriors, part of the **Cornerstone Building Brands** family.
ALL RIGHTS RESERVED. 7601093611101/RevC/MS/CG/1120



SIDING + ACCESSORIES | WINDOWS + DOORS | STONE VENEER | TRIM + MOULDINGS | FENCE + RAILING